

SANYO

Dual Camera
VPC-TH1EX
VPC-TH1
VPC-TH1GX

Xacti QUICK GUIDE

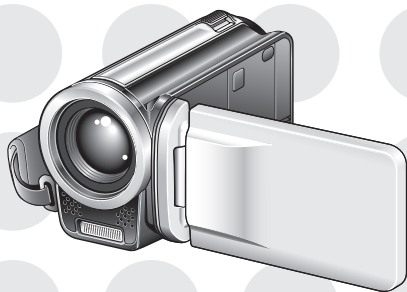

STEP 1 RECORD A VIDEO CLIP

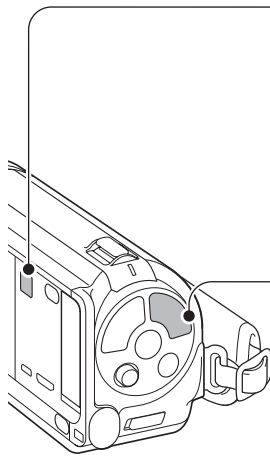

- 1 Turn on the camera.
 - Press the ON/OFF button for at least 1 second.
 - If the screen to set the date and time appears, press the MENU button 2 times to cancel it.
 - 2 Press the [RECORD] button to begin recording a video clip.
 - To stop recording, press the [RECORD] button again.
- 

If the image is not captured...

Is there enough power left in the battery? Recharge the battery pack.

(See "Charge the battery pack" on the reverse side.)

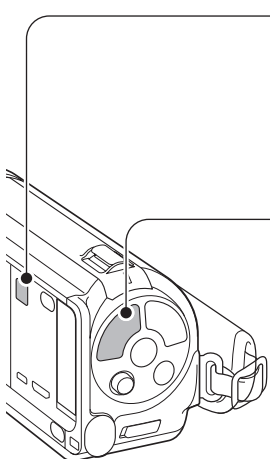
STEP 2 CAPTURE A STILL IMAGE

- 1 Turn on the camera.
 - 2 Press the [CAMERA] button.
- 
- 

You can capture a still image while recording a video clip.

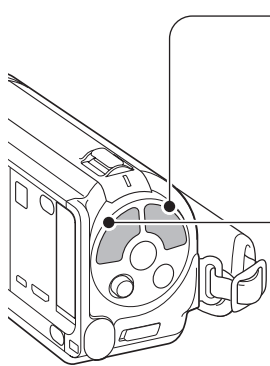
- 1 Press the [RECORD] button to begin recording.
 - 2 To capture a single shot while recording, press the [CAMERA] button.
 - The scene at the time the [CAMERA] button was pressed is captured as a still image.
- 

STEP 3 VIEWING IMAGES

1 Press the REC/PLAY button.

- The last recorded image is displayed.

2 Select the image to play back.

- Toggle the SET button left, right, up or down to move the orange frame to the file you wish to play back.

3 Press the SET button.

- The image you selected in step 2 is displayed fullscreen.
- If a video clip was selected, playback begins.

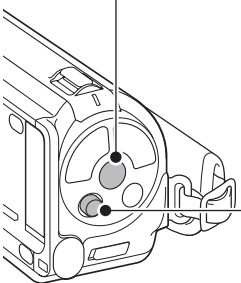

STEP 4 DELETING IMAGES

1 Display the image that you want to delete.

2 Toggle the SET button up.

- The Confirm Delete Screen appears.

3 Select "DELETE", and press the SET button.

- The current image is deleted.
- To return to the Playback Screen, select "EXIT", and press the SET button.

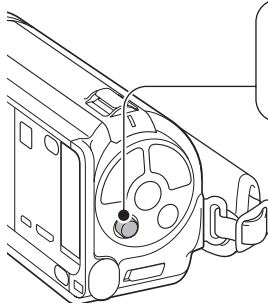

Did your photos turn out the way you hoped?

Even if you make a mistake, it's easy to delete the pictures you aren't satisfied with. Unlike film cameras, with a dual camera you can take all the photos you want, keep the ones you like and delete the rest.

INSTALL THE BATTERY PACK AND CARD

Insert the battery pack

After installing the battery pack, connect the AC adaptor (supplied) to the camera's DC IN terminal and charge the battery.

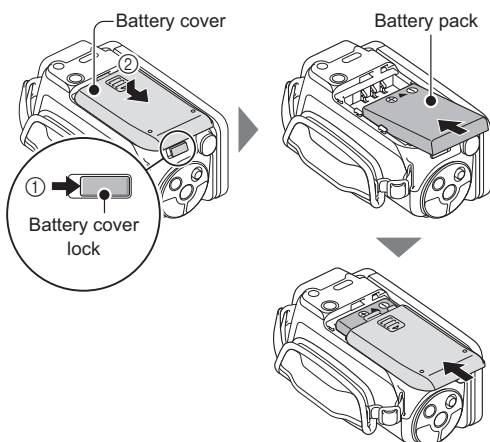

Insert the card

- An SD Memory Card is not included with your camera. Please purchase a commercially sold card.

- In this manual, the SD Memory Card is referred to as the "card".

